

## SMAJ SERIES

### 1. Features

- For surface mounted applications in order to optimize board space
- Low profile package
- Built-in strain relief
- Glass passivated junction
- Low inductance
- Excellent clamping capability
- Fast response time
- Typical IR less than 1μA above 10V
- Plastic package has underwriters laboratory flammability 94V-0
- High Temperature soldering: 260°C/10 seconds at terminals
- Plastic package has underwriters laboratory flammability 94V-0
- Meets MSL level 1, per J-STD-020
- AEC-Q101 qualified

### 2. Mechanical Data

- Case: JEDEC DO-214AC. Molded plastic over glass passivated junction
- Terminal: Solder plated, solderable per MIL-STD-750, Method 2026
- Polarity: Color band denotes cathode except bi-directional models
- Standard Packaging: 12mm tape
- Weight: 0.07g

### 3. Maximum Ratings and Characteristics

Ratings at 25° ambient temperature unless otherwise specified

Rating	Symbol	Value	Units
Peak pulse power dissipation at 10/1000us waveform	P <sub>PPM</sub>	400	W
Peak pulse current of at 10/1000us waveform	I <sub>PPM</sub>	See Table	A
Steady state power dissipation at TA=50°C	P <sub>M(AV)</sub>	3.3	W
Peak forward surge current, 8.3ms single half sine-wave superimposed on rated load (JEDEC Method)	I <sub>FSM</sub>	40	A
Operating junction and Storage Temperature Range	T <sub>J</sub> , T <sub>STG</sub>	-65 to 150	°C
Typical thermal resistance junction to lead	R <sub>θJL</sub>	30	°C/W
Typical thermal resistance junction to ambient	R <sub>θJA</sub>	120	°C/W



Notes:

1. Non-repetitive current pulse, per Fig.3 and derated above TA=25°C per Fig.2.
2. 8.3ms single half sine-wave, or equivalent square wave, duty cycle=4 pulses per minutes maximum.
3. Mounted on 5.0mmx5.0mm copper pads to each terminal.

4. Electrical Characteristics (TA=25°C)

Part Number	Part Number	Marking		Reverse Stand off Voltage V <sub>R</sub> (Volts)	Breakdown Voltage V <sub>BR</sub> (Volts) @ I <sub>T</sub>		Test Current I <sub>T</sub> (mA)	Maximum Clamping Voltage V <sub>C</sub> @ I <sub>PP</sub> (V)	Maximum Peak Pulse Current I <sub>PP</sub> (A)	Maximum Reverse Leakage I <sub>R</sub> @ V <sub>R</sub> (µA)	ROHS2.0
					MIN	MAX					
SMAJ5.0A	SMAJ5.0CA	AE	WE	5	6.4	7	10	9.2	43.5	800	y
SMAJ6.0A	SMAJ6.0CA	AG	WG	6	6.67	7.37	10	10.3	38.8	800	y
SMAJ6.5A	SMAJ6.5CA	AK	WK	6.5	7.22	7.98	10	11.2	35.7	500	y
SMAJ7.0A	SMAJ7.0CA	AM	WM	7	7.78	8.6	10	12	33.3	200	y
SMAJ7.5A	SMAJ7.5CA	AP	WP	7.5	8.33	9.21	1	12.9	31	100	y
SMAJ8.0A	SMAJ8.0CA	AR	WR	8	8.89	9.83	1	13.6	29.4	50	y
SMAJ8.5A	SMAJ8.5CA	AT	WT	8.5	9.44	10.4	1	14.4	27.8	20	y
SMAJ9.0A	SMAJ9.0CA	AV	WV	9	10	11.1	1	15.4	26	10	y
SMAJ10A	SMAJ10CA	AX	WX	10	11.1	12.3	1	17	23.5	5	y
SMAJ11A	SMAJ11CA	AZ	WZ	11	12.2	13.5	1	18.2	22	1	y
SMAJ12A	SMAJ12CA	BE	XE	12	13.3	14.7	1	19.9	20.1	1	y
SMAJ13A	SMAJ13CA	BG	XG	13	14.4	15.9	1	21.5	18.6	1	y
SMAJ14A	SMAJ14CA	BK	XK	14	15.6	17.2	1	23.2	17.2	1	y
SMAJ15A	SMAJ15CA	BM	XM	15	16.7	18.5	1	24.4	16.4	1	y
SMAJ16A	SMAJ16CA	BP	XP	16	17.8	19.7	1	26	15.4	1	y
SMAJ17A	SMAJ17CA	BR	XR	17	18.9	20.9	1	27.6	14.5	1	y
SMAJ18A	SMAJ18CA	BT	XT	18	20	22.1	1	29.2	13.7	1	y
SMAJ20A	SMAJ20CA	BV	XV	20	22.2	24.5	1	32.4	12.3	1	y
SMAJ22A	SMAJ22CA	BX	XX	22	24.4	26.9	1	35.5	11.3	1	y
SMAJ24A	SMAJ24CA	BZ	XZ	24	26.7	29.5	1	38.9	10.3	1	y
SMAJ26A	SMAJ26CA	CE	YE	26	28.9	31.9	1	42.1	9.5	1	y
SMAJ28A	SMAJ28CA	CG	YG	28	31.1	34.4	1	45.4	8.8	1	y
SMAJ30A	SMAJ30CA	CK	YK	30	33.3	36.8	1	48.4	8.3	1	y
SMAJ33A	SMAJ33CA	CM	YM	33	36.7	40.6	1	53.3	7.5	1	y
SMAJ36A	SMAJ36CA	CP	YP	36	40	44.2	1	58.1	6.9	1	y
SMAJ40A	SMAJ40CA	CR	YR	40	44.4	49.1	1	64.5	6.2	1	y
SMAJ43A	SMAJ43CA	CT	YT	43	47.8	52.8	1	69.4	5.8	1	y



# SMAJ SERIES

Rev-2021-6

www.sitcores.com

Part Number	Part Number	Marking		Reverse Stand off Voltage $V_R$ (Volts)	Breakdown Voltage $V_{BR}$ (Volts) @ $I_R$		Test Current $I_R$ (mA)	Maximum Clamping Voltage $V_C @ I_{PP}$ (V)	Maximum Peak Pulse Current $I_{PP}$ (A)	Maximum Reverse Leakage $I_R @ V_R$ ( $\mu$ A)	ROHS2.0
					MIN	MAX					
SMAJ45A	SMAJ45CA	CV	YV	45	50	55.3	1	72.7	5.5	1	y
SMAJ48A	SMAJ48CA	CX	YX	48	53.3	58.9	1	77.4	5.2	1	y
SMAJ51A	SMAJ51CA	CZ	YZ	51	56.7	62.7	1	82.4	4.9	1	y
SMAJ54A	SMAJ54CA	RE	ZE	54	60	66.3	1	87.1	4.6	1	y
SMAJ58A	SMAJ58CA	RG	ZG	58	64.4	71.2	1	93.6	4.3	1	y
SMAJ60A	SMAJ60CA	RK	ZK	60	66.7	73.7	1	96.8	4.1	1	y
SMAJ64A	SMAJ64CA	RM	ZM	64	71.1	78.6	1	103	3.9	1	y
SMAJ70A	SMAJ70CA	RP	ZP	70	77.8	86	1	113	3.5	1	y
SMAJ75A	SMAJ75CA	RR	ZR	75	83.3	92.1	1	121	3.3	1	y
SMAJ78A	SMAJ78CA	RT	ZT	78	86.7	95.8	1	126	3.2	1	y
SMAJ85A	SMAJ85CA	RV	ZV	85	94.4	104	1	137	2.9	1	y
SMAJ90A	SMAJ90CA	RX	ZX	90	100	111	1	146	2.7	1	y
SMAJ100A	SMAJ100CA	RZ	ZZ	100	111	123	1	162	2.5	1	y
SMAJ110A	SMAJ110CA	SE	VE	110	122	135	1	177	2.3	1	y
SMAJ120A	SMAJ120CA	SG	VG	120	133	147	1	193	2.1	1	y
SMAJ130A	SMAJ130CA	SK	VK	130	144	159	1	209	1.9	1	y
SMAJ150A	SMAJ150CA	SM	VM	150	167	185	1	243	1.6	1	y
SMAJ160A	SMAJ160CA	SP	VP	160	178	197	1	259	1.5	1	y
SMAJ170A	SMAJ170CA	SR	VR	170	189	209	1	275	1.5	1	y
SMAJ180A	SMAJ180CA	ST	VT	180	201	222	1	292	1.4	1	y
SMAJ200A	SMAJ200CA	SV	VV	200	224	247	1	324	1.2	1	y
SMAJ220A	SMAJ220CA	SX	VX	220	246	272	1	356	1.1	1	y
SMAJ250A	SMAJ250CA	SZ	VZ	250	279	309	1	405	1	1	y
SMAJ300A	SMAJ300CA	TE	UE	300	335	371	1	486	0.8	1	y
SMAJ350A	SMAJ350CA	TG	UG	350	391	432	1	567	0.7	1	y
SMAJ400A	SMAJ400CA	TK	UK	400	447	494	1	648	0.6	1	y
SMAJ440A	SMAJ440CA	TM	UM	440	492	543	1	713	0.6	1	y

For bidirectional type having VR of 10 volts and less, the IR limit is double.

5. Ratings and Characteristic Curves (TA =24°C unless otherwise noted)

Figure 1. Peak Pulse Power Rating Curve

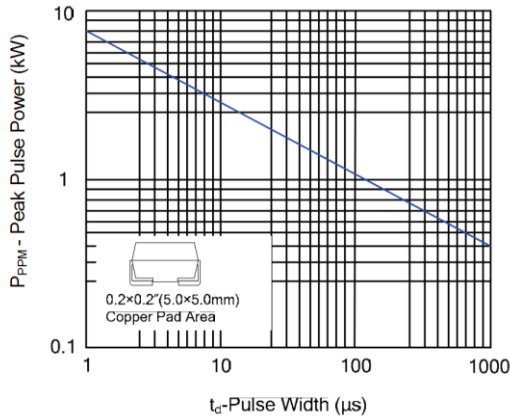

Figure 2 Pulse Derating Curve

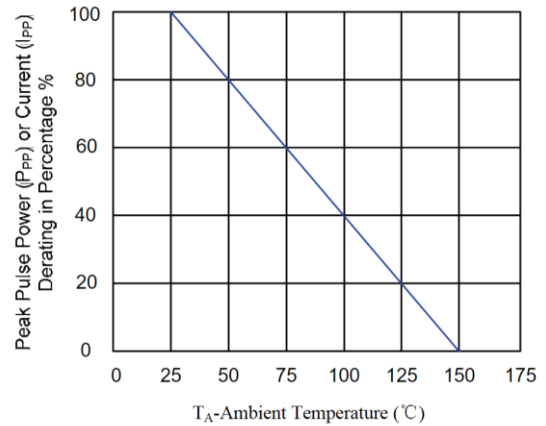

Figure 3 Pulse Waveform

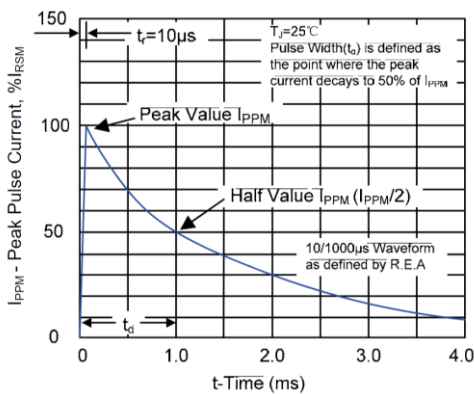

Figure 4 Typical Junction Capacitance

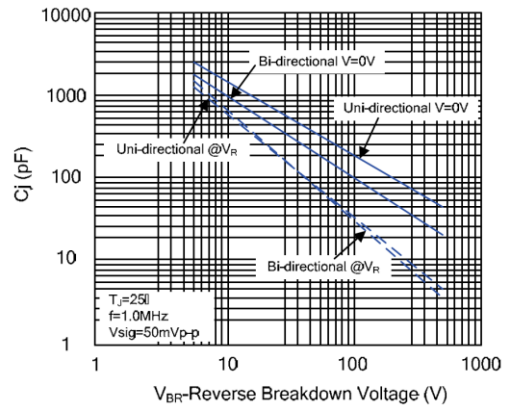

Figure 5 Steady State Power Dissipation Derating Curve

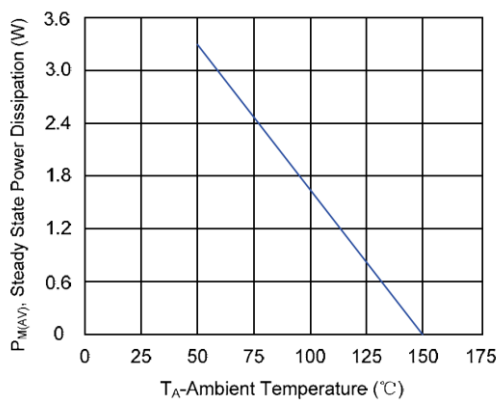
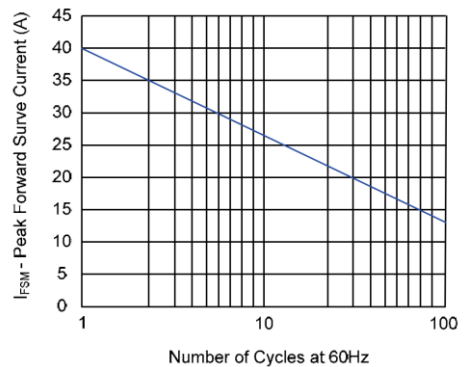
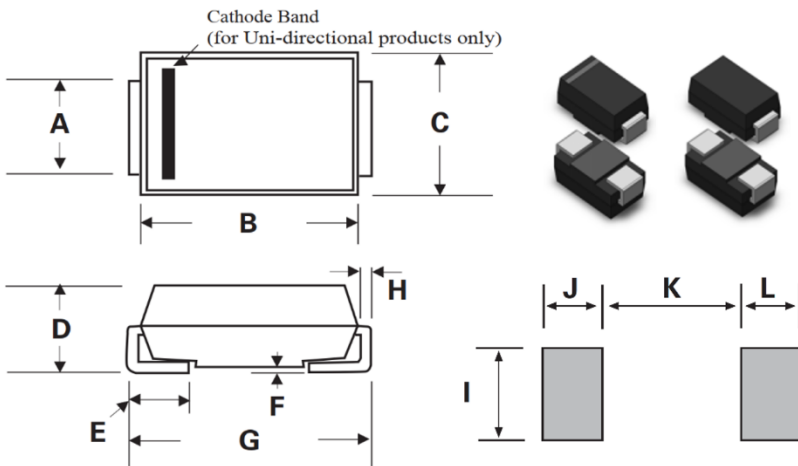

Figure 6 Maximum Non-Repetitive Forward Surge Current Uni-Directional Only



**6. Dimension (SMA/DO-214AC)**



Dimensions	Inches		Millimeters	
	Min	Max	Min	Max
A	0.049	0.065	1.25	1.65
B	0.157	0.177	3.99	4.5
C	0.1	0.11	2.54	2.79
D	0.078	0.09	1.98	2.29
E	0.03	0.06	0.78	1.52
F	-	0.008	-	0.203
G	0.194	0.208	4.93	5.28
H	0.006	0.012	0.152	0.305
I	0.07	-	1.8	-
J	0.082	-	2.1	-
K	-	0.09	-	2.3
L	0.082	-	2.1	-



**DISCLAIMER**

SIT PROVIDES TECHNICAL AND RELIABILITY DATA (INCLUDING DATASHEETS), DESIGN RESOURCES (INCLUDING REFERENCE DESIGNS), APPLICATION OR OTHER DESIGN ADVICE, SAFETY INFORMATION, AND OTHER RESOURCES “AS IS” AND WITH ALL FAULTS, AND DISCLAIMS ALL WARRANTIES, EXPRESS AND IMPLIED, INCLUDING WITHOUT LIMITATION ANY IMPLIED WARRANTIES OF MERCHANTABILITY, FITNESS FOR A PARTICULAR PURPOSE OR NON-INFRINGEMENT OF THIRD PARTY INTELLECTUAL PROPERTY RIGHTS.

These resources are intended for skilled developers designing with SIT products. You are solely responsible for

- (1) selecting the appropriate SIT products for your application,
- (2) designing, validating and testing your application
- (3) ensuring your application meets applicable standards, and any other safety, security, or other requirements. These resources are subject to change without notice. SIT grants you permission to use these resources only for development of an application that uses the SIT products described in the resource. Other reproduction and display of these resources are prohibited. No license is granted to any other SIT intellectual property right or to any third party intellectual property right. SIT disclaims responsibility for, and you will fully indemnify SIT and its representatives against, any claims, damages, costs, losses, and liabilities arising out of your use of these resources. SIT’s products are provided subject to SIT’s Terms of Sale or other applicable terms available either on [sitcores.com](http://sitcores.com) or provided in conjunction with such SIT products. SIT’s provision of these resources does not expand or otherwise alter SIT’s applicable warranties or warranty disclaimers for SIT products